

# FI36WCC-R02

36", WINE CELLAR, 0FW Model

FULLY INTEGRATED

INTEGRATED® SERIES

*Fhiaba*

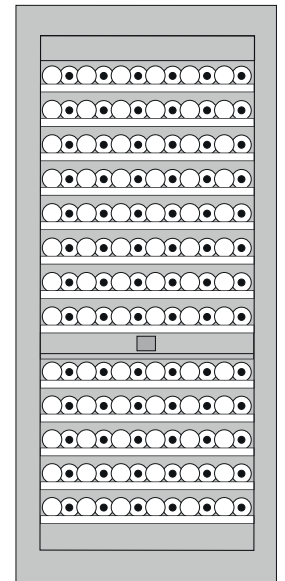
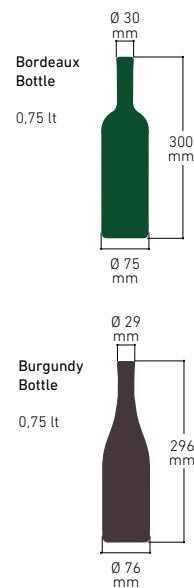

## FEATURES

- Made in Italy
- OptiView™: OptiView LED lights
- ProVent™: Uniform air circulation maintains consistent temperatures throughout the appliance resulting in better food preservation
- Humidity Control: Choose between high, medium and low humidity – particularly important for wine storage
- Total No Frost: Temperature control helping mitigate cooling loss when opening the refrigerator door. No more frost build-up that requires defrosting
- EquiLance™: Achieve a seamless built-in look with Fhiaba's innovative door hinge

## GENERAL PROPERTIES

Equilance Hinge	YES
Soft-Closing Glides	NO
Low Vibration	YES
OptiView (Led Light Spots)	YES
Shelves	13
Type Of Shelves	WOOD
Door Bins	N/A
Fridge Interior Drawers	N/A
Freezer Drawers	N/A
Evenlift Shelves	NO
Full Extension Shelves 90° Door Opening	YES
Full Extension Drawers 90° Door Opening	NO
Defrost Process	AUTOMATIC
Ice Maker With Water Filter	NO
Door Open Alarms	YES
Shopping Fridge	NO
Shopping Freezer	NO
Power Failure Alert	YES
Water Dispenser With Water Filter	NO

# FI36WCC-R02

36", WINE CELLAR, 0FW Model

FULLY INTEGRATED

INTEGRATED® SERIES

## PRODUCT DETAIL

*Fhiaba*

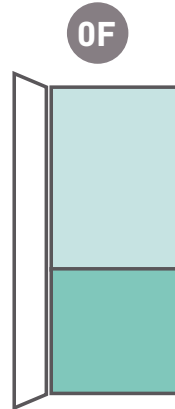
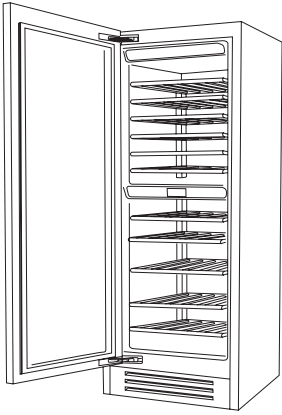

1D | 2M

wine cellar

D = door

M = separate microclimates

### CAPACITY

Net Capacity	20.8 cuft (590 l)
Upper Compartment Wine Cellar Capacity (Bottles)	96
Lower Compartment Wine Cellar Capacity (Bottles)	90

### TECHNICAL DETAILS

Total Absorbed Current (A)	2.5
Voltage (V)	115
Frequency (Hz)	60
Power Cord Length	78 3/4" (2 m)
Plug Type	3-prong (15 Amp)
Climate Class	SN/T
Refrigerant (Gas)	R600a
Water Connection / Female Attachment	N/A

### EFFICIENCY

Estimated Yearly Electricity Use	255 kwh
----------------------------------	---------

### DIMENSIONS & WEIGHT

Height Of The Product (Minimum)	83 1/2" (2120 mm)
Adjustable Feet Height	up to 1" (25 mm)
Width Of The Product	35 7/8" (912 mm)
Depth Of Product Without Handle	24" (610 mm)
Cut-out Height	84" (2134 mm)
Cut-out Width	36" (914 mm)
Cut-out Depth	min 24" (610 mm) + panel thickness for flush install
Net Weight	381 lbs (173 kg)
Gross Weight	428 lbs (194 kg)

### TEMPERATURE RANGES

Climate Zones	2
Compartment 1 / Upper Temperature	from 39°F (4°C) to 64°F (18°C)
Compartment 2 / Middle Temperature	N/A
Compartment 3 / Low Temperature	from 39°F (4°C) to 64°F (18°C)



# FI36WCC-R02

36", WINE CELLAR, OFW Model

FULLY INTEGRATED

INTEGRATED® SERIES

## PRODUCT SPECIFICATIONS AND DIMENSIONS

### TOP VIEWS



Door swing clearance

36" model: 1489 mm (58 5/8")

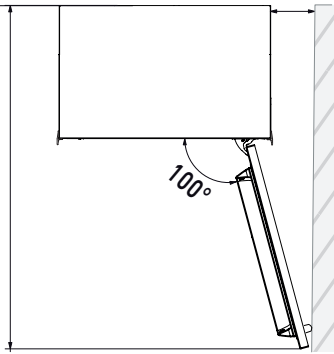

Minimum distance from the wall (hinge side)

36" model: 158 mm (6 1/4")

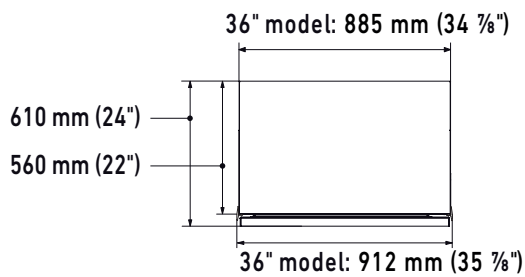

Width of the body of the appliance

Width of appliance with mounting brackets installed (effective width)

### Electrical Connection

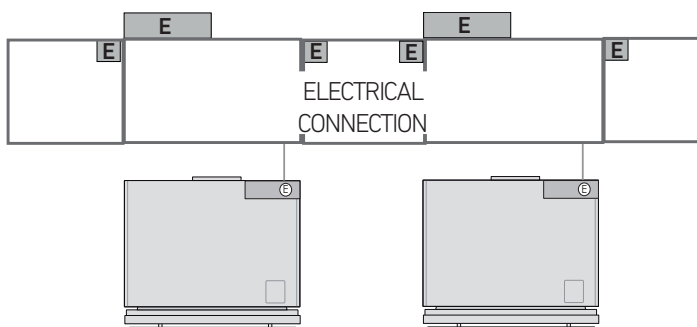

Electrical and water connections (if applicable) should be reachable without having to uninstall the appliance. If the connections must be made directly behind the appliance then it is recommended to recess those connections.

**IMPORTANT:** do not put the water shut-off valve behind the appliance where it will be inaccessible.